



PRODUCT SHEET

Operation and maintenance Smart

Manufacturer

LUBE INDUSTRIES Srl Via dell'Industria, 4 - Treia (MC)

Type of Product

Kitchen furniture, **SMART** model



Caution

This product data sheet complies with the specifications set out by Italian Legislative Decree no. 206 dated 6th September 2005 "Consumer Code".

Materials Used - Alkorcell

DOORS AND DEEP DRAWER FRONTS

Door consisting of an MDF frame, 18 mm thick (compliant with US EPA TSCA Title VI), covered in wood-effect Alkorcell in various colours.

DRAWER FRONTS

As doors.

GLASS DOORS AND DEEP DRAWER FRONTS

Door consisting of an MDF frame, 18 mm thick (compliant with US EPA TSCA Title VI), covered in brushed-metal-effect Alkorcell and extra-clear tempered

glass, 4 mm thick, with rough edge, screen-printed with fabric effect in two colours.

HANDLE - BRIDGE VERSION

Applied on the front of the door, in zamak alloy with various finishes.

Materials Used - PET

DOORS AND DEEP DRAWER FRONTS

Door consisting of an MDF frame, 18 mm thick (compliant with US EPA TSCA Title VI), covered in single-colour matt PET, available in various colours.

DRAWER FRONTS

As doors.

GLASS DOORS AND DEEP DRAWER FRONTS

Door consisting of an MDF frame, 18 mm thick (compliant with US EPA TSCA Title VI), covered in single-colour matt PET and extra-clear tempered glass, 4 mm thick, with rough edge, screen-printed with fabric effect in various colours.

HANDLE - BRIDGE VERSION

Applied on the front of the door, in zamak alloy with various finishes.

Components Description

DRAWER STRUCTURE AND SHELVES

Consisting of 18 mm thick melamine-faced chipboard panels in accordance with the US EPA TSCA Title VI standard (with very low formaldehyde emission).

The shelves are 18 mm thick and equipped with built-in shelf supports with locking device. They can also be made of tempered glass (6 mm thick), grounded on the edges.

EDGE

Edge in ABS or Polypropylene (PP) glued with thermosetting polyurethane glues 1 mm thick on the front parts of the unit sides and shelves and 0.5 mm thick on the lower and upper parts of the unit sides and on the sides and rear part of the internal shelves. Made of paper for the non-visible parts of furniture (back).

BACKS

Consisting of 2.8 mm thick high-density fibre panels compliant with E1 and US EPA TSCA Title VI for formaldehyde emissions, wall units with polypropylene veneers and painted bases and columns.

WORKTOP

Laminate worktop: 38 or 58 mm thick water-repellent wood particle board coated with high pressure laminate (HPL). For worktops in other materials, please refer to the "Useful information" section.

SINK

In sheet 18/10 stainless steel made using a single-casting or electrically welded tubs, with a smooth or "embossed" finish. For sinks in other materials, please refer to the "Useful information" section.

BRACKETS

Faced bracket: melamine faced wood particle board panel (class E1); ABS edging.

Veneered bracket: wood particle board panel (class E1) veneered with "slices" of wood (which vary depending on the model) and lacquered using

acrylic/polyurethane products.

FRAMES

In pine wood or MDF (class E1) veneered with "slices" of wood (which vary depending on the model); acrylic/polyurethane lacquering.

SINK UNIT BASE COATING

In chequered aluminium or lacquered plastic to protect the sink unit from water seepage.

FEET

In knock-resistant plastic material (PVC) and height-adjustable, these are screwed to the bottom of the cabinet using special bushing, without requiring any drilling in the lower part of the casing (thus completely avoiding the creation of areas in which dirt may accumulate or through which water could leak into the base and sink cabinets).

They are also available in aluminium and can be adjusted and mounted on a special base structure (also made using an aluminium profile).

SKIRTING

These elements may be made using anodised or lacquered aluminium, or PVC coated with decorative melamine foil, and have a rubber seal at the top and bottom.

REFRIGERATOR UNIT BASE

In rigid plastic material (PVC), drilled in the centre to allow any leaking water to escape and to protect the main cabinet column.

BACKSPLASH FOR WORKTOPS

In aluminium or rigid knock-resistant PVC with laminate decoration.

HINGES

In sheet steel and zamak alloy, copper-plated and nickel-plated for resistance to corrosion; adjustable in three directions.

DRAWERS AND TOTAL EXTRACTION DEEP DRAWERS (INTERNAL STRUCTURE)

The structure may consist of a 16 mm thick wood particle base (extremely low formaldehyde emission) faced in grey laminate with side and back panels in galvanised and lacquered sheet steel for protection against corrosion. Alternatively the structure can be made entirely of solid ash and plywood; sliding takes place by means of total extraction runners with a grooved system for anti-detachment locking and automatic closure which is activated in the final 4 cm. The soft-close system (blu-motion) is also supplied as standard.

PLATE DRAINING RACKS AND BASKETS

In electrically welded metal wire; they may be plasticised with polymer resin, nickel-plated or chrome-plated and coated with a transparent plastic sheath (Crominox finish).

TABLES

Top: may be a wood particle panel (class E1) coated with HPL plastic laminate (see laminate worktop) or veneered with "slices" of wood and lacquered with water-based, polyurethane or acrylic shades, or it may be made using glass, granite or natural stone.

Borders and base structure: these may be made using metal or plywood panels, faced or veneered with "slices" of wood (these vary depending on the model). Legs: these may be made using metal or solid wood; lacquering is carried out using acrylic/polyurethane products.

CHAIRS AND STOOLS

Structure: this may be in tubular metal lacquered with thermosetting powders, or in solid wood lacquered using water-based (impregnating) and acrylic/polyurethane products (base).

Seat and Backrest: these may be made using synthetic material (methacrylate), solid wood, plywood, upholstered fabric or simulated wicker.

Note: each type of chair or table is identified at the site of purchase by the relevant adhesive label on the packaging.

Safety

FORMALDEHYDE EMISSIONS

DECLARATION OF CONFORMITY FOR FORMALDEHYDE EMISSIONS

The undersigned SILEONI PACIFICO, legal representative of the company LUBE INDUSTRIES srl, via dell'Industria 4 Treia (MC), VAT no. 01504060433 declares, under his sole responsibility, that all wood-based components of the kitchens manufactured by the company, to which this declaration refers, comply with the following standard: UNI EN 13986:2015 "Wood-based panels for use in construction - characteristics, assessment of conformity and marking", exclusively for what is specified in table B1 therein indicating "classes of formaldehyde E1" according to the provisions of the Italian Ministerial Decree of 10 October 2008 (formaldehyde emissions < 0.1 ppm or < 0.124 mg/m³, according to EN 717-1:2004). **He also declares that exclusively for the components that make up the structures of the furniture, the provisions of US regulation EPA TSCA Title VI (LUBE, CREO and BORGO ANTICO collections).**

Treia, 09/05/2019



Pacifico Sileoni

LUBE Industries Srl

Via dell'Industria, 4 - 62010 TREIA (MC) Italia
Società unipersonale controllata da Lube Holding Srl
Cap. Sociale € 13.670.000,00 i.v.
C.F. - P.IVA - R.I. CJA MC 01504060433
N. Iscr. REA MC 157803
Tel. 0733 8401 (r.a.) - Fax 0733 840222-333
info@cucinelube.it - www.cucinelube.it
info@creokitchens.it - www.creokitchens.it

PERMITTED LOADS

Wall unit supports (hooks): max. flexing resistance up to 145 kg.

Drawer runners (partial extraction): max. dynamic load 25 kg; static 40 kg.

Drawer runners (total extraction): max. dynamic load 30 kg; static 50 kg.

Hinges: wear tests did not result in any significant signs of deterioration after 80,000 cycles (70x60 cm door weighing 8.8 kg with 2 hinges, subjected to repeated opening and closing).

Max. tensile strength when opened: 130 N (in the test conditions specified above).

Tempered glass panels: if broken, these glass panels shatter into small pieces so as not to create dangerous and sharp shards.

ASSEMBLY

- Make sure that assembly is carried out by authorised personnel, and do not make any modifications to the cabinets as this may compromise structure stability; in fact, the units are at risk of tipping over or collapsing if they are not installed properly.

- Also check the suitability of the wall/ceiling and make sure the fixing devices can withstand the forces generated.

ENVIROMENT

When replacing the cabinets, do not dispose of them as normal; contact the solid urban waste disposal authority so that it can be taken to an appropriate waste disposal site.

Useful Information

WORKTOPS

LAMINATE WORKTOP

The plastic high-pressure laminate (HPL) coating the worktop is a very strong material which guarantees high quality standards in terms of resistance to scratches, heat, stains, knocks and abrasion, in compliance with EN 438.

MARBLE OR GRANITE WORKTOP

These are very delicate due to their porosity (although granite is less porous) and are therefore more likely to be stained by any liquids spilt on the surface; marble is also particularly susceptible to attack from even weak acids contained, for example, in vinegar or lemon juice. The Manufacturer will supply a suitable pore-blocking treatment to encourage stain removal; this treatment should be applied once or twice a year for optimal surface protection.

MARBLE OR GRANITE AGGLOMERATE WORKTOP

Made using an agglomerate of 95-96% natural marble or granite with a grading from 0 to 90 mm combined with 4-5% polyester resin; it shares all the features of marble or granite and therefore requires the same level of care; its main advantage is that it offers greater flexibility in terms of worktop shapes and, in the event of abrasion or chipping (caused by heavy objects falling onto the surface), it can be repaired using special kits.

SYNTHETIC WORKTOP

The worktop is made using a sheet of variable thickness (from 6 mm to 20 mm) created by mixing 75-95% mineral powders (such as quartz, natural stone, etc.) with pigments (2-5%) and acrylic resins (8-25%), supported if necessary by a wooden panel (class E1) or synthetic panel (polystyrene, styrene, Eulithe®) of variable thickness; the edging may be made using the same material as the surface or constructed using profiles in other materials (aluminium, wooden edging, ABS, etc.).

This worktop, depending on its resin content, offers considerable advantages as it is solid, resistant to abrasion, can be repaired, does not react to chemical agents, is not porous and therefore does not absorb liquids. It is not always easy to recycle.

STRATIFIED LAMINATE WORKTOP

Constructed using laminate with a 10 mm thick supporting resin layer, glued to a 38 mm thick wood particle board panel (class E1) which is water- and fire-resistant. Thanks to its mechanical characteristics, it is extremely resistant to abrasion and knocks, and is completely waterproof.

STAINLESS STEEL WORKTOP

This consists of a wood particle board panel (class E1) coated with 1 mm thick AISI 304 2B sheet steel and finished with scotch brite; it is completely stain-resistant and offers particularly high levels of food hygiene.

However, sharp objects or abrasive products should not be used as they may damage the surface, which offers little scratch resistance. A great advantage of this product is that kitchen sinks and hobs can be welded directly to it, thus creating continuity and avoiding joins in which dirt may collect.

TILED WORKTOP

Made using glazed ceramic, porcelain stoneware or natural stone tiles applied to a water-repellent plywood panel and grouted with a waterproof product;

the ceramic surface is stain-resistant, but the glaze may be chipped if struck with a sharp object.

STONEWARE = Ceramic made using a white or coloured vitrified paste, without a glaze. Clinker, earthenware and extra-fine stoneware for domestic use also belong to this category.

PORCELAIN STONEWARE = Tiles made using pressing techniques, with a very low overall porosity, consisting of a light paste which can be uniformly coloured or shaded using a mixture of powders and granules of various colours and sizes. The composition of the paste is very similar to that of light-coloured stoneware, but only raw materials with a very low ferrous oxide percentage are selected. The paste is pressed with specific loads 50% greater than those used for glazed light stoneware. Baking takes less than an hour at a temperature of approximately 1200°. The tiles may also be polished before or after they are laid, in order to enhance their aesthetic features. This material is resistant to frost, acids and alkali, with extremely low porosity and high mechanical resistance.

GLASS WORKTOP

This consists of a sheet of 12 mm thick extra-light glass which has been coloured and powertech tempered for greater resistance to knocks; it is glued to a water-repellent wooden support (wood particle board panel, class E1 V70) of variable thickness, with an anodised aluminium profile applied along the edge. This worktop is waterproof, stain-resistant and hygienic.

CLEANING RECOMMENDATIONS

Clean laminated, synthetic and tiled worktops with a damp and well wrung-out soft cloth. A normal liquid detergent can be added for stains, preferably neutral or specifically for the surface to be cleaned. Do not use highly abrasive products or products containing aggressive and corrosive substances, such as bleach, acid, alcohol, etc., for any of the materials. We recommend using a household sponge or microfibre cloth for all materials and avoiding use of rough cleaning materials (abrasive sponges, scourers, etc.). Do not use steam cleaners for the grouting on tiled products. We recommend using lime-scale gel products instead. Stainless steel worktops tend to become stained with the lime in the water, but there are now specific products for stainless steel surfaces which remove these stains easily. Be careful not to use detergents containing chlorine or its compounds (chlorine causes stains similar to rust) or abrasive products (creams, powder detergents, metal scourers, etc.), since the stainless steel scratches easily. Use only water and neutral soap to clean marble, granite and composite surfaces and avoid non-specific detergents. It is important to remove dirt and fresh stains immediately, since the substances could penetrate into the material and be absorbed even after a short period of time. To remove smears or stains (such as lime), rub with a bicarbonate and water paste, leave to act for several minutes and then wipe off with a damp sponge. It is also important to repeat the impermeability treatment periodically using specific products.

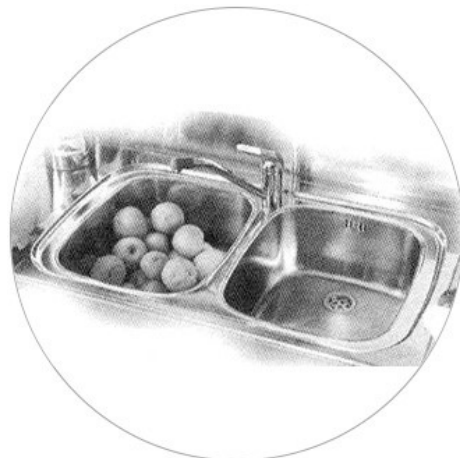

SINKS

STAINLESS STEEL SINK

These fall into two categories: single-casting models made using a single sheet, with shallower tubs and thinner steel, and those with welded tubs which are deeper, squarer and therefore offer a greater capacity.

Steel sinks tend to show water marks and limescale deposits easily; however, these can be removed using the special products currently available on the market. An embossed or "scratch-resistant" finish consisting of raised geometric patterns on the surface is also available; this increases the scratch resistance of the sink, but makes cleaning more difficult.

RESIN SINK

Made using cast resins and polymeric minerals, this is resistant to chemical agents and stains, but may lose elasticity over time and break if subjected to thermal shocks (a sudden switch from cold to hot water, for example); it is initially very easy to clean, but this process

becomes more complicated over time as microscratches form in the surface and capture dirt. It is not easy to recycle. For detailed information about the features of the various sink materials, please refer to the worktops section.



WOOD

Wood is a natural material with all the characteristics this implies. Differences in grain or shade between the different parts cannot therefore be considered as a cause for complaint. Cucine Lube has nonetheless included strict controls on wood finishes and combinations in its Quality System, in order to reduce any problems to a minimum. Exposure of wood to direct sunlight may cause entirely normal changes in colour, linked to the natural change in the material. The wood matures over time and may turn a slightly different shade, which should not be considered as a defect. It should be remembered that, even after processing, it behaves like a living product, changing in volume as the humidity in the surrounding environment changes.

Advice: Cleaning and Maintenance

WOODEN OR VENEERED PARTS

Gently clean with a damp cloth and dry carefully. Use neutral detergents for wood to remove stains. Do not use non-specific detergents and sprays, which could damage the final coat of varnish. Wipe dry any drops of water and steam to prevent the varnish flaking and other damage, particularly on the sink base, dishwasher, oven and hood. Do not use products containing corrosive substances, such as solvents, acetone, ammonia, alcohol, etc., under any circumstances.

PLASTIC LAMINATE, POLYMER-COATED OR MELAMINE-FACED PARTS

Clean using a soft cloth (microfibre) dampened with warm water and neutral soap. Always rinse treated surfaces thoroughly. Do not use aggressive products (e.g. degreasers), alcohol, solvents or other detergents, nor abrasive sponges and similar supports, as they may permanently scratch the parts being treated.

LACQUERED PARTS

Clean using a soft cloth and liquid detergent, then rinse and dry carefully; do not use abrasives or products containing alcohol or solvents (acetone, triline or ammonia).

WORKTOPS

Clean laminated, synthetic and tiled worktops with a damp and well wrung-out soft cloth. A normal liquid detergent can be added for stains, preferably neutral or specifically for the surface to be cleaned. Do not use highly abrasive products or products containing aggressive and corrosive substances, such as bleach, acid, alcohol, etc., for any of the materials. We recommend using a household sponge or microfibre cloth for all materials and avoiding use of rough cleaning materials (abrasive sponges, scourers, etc.). Do not use steam cleaners for the grouting on tiled products. We recommend using lime-scale gel products instead. Stainless steel worktops tend to become stained with the lime in the water, but there are now specific products for stainless steel surfaces which remove these stains easily. Be careful not to use detergents containing chlorine or its compounds (chlorine causes stains similar to rust) or abrasive products (creams, powder detergents, metal scourers, etc.), since the stainless steel scratches easily. Use only water and neutral soap to clean marble, granite and composite surfaces and avoid non-specific detergents. It is important to remove dirt and fresh stains immediately, since the substances could penetrate into the material and be absorbed even after a short period of time. To remove smears or stains (such as lime), rub with a bicarbonate and water paste, leave to act for several minutes and then wipe off with a damp sponge. It is also important to repeat the impermeability treatment periodically using specific products.

SINKS

For sinks in various materials (steel or synthetic resins such as fragranite, cristalite or ekotek), follow the instructions for worktops in the same material. Do not leave opened packets or bottles of detergent or other acidic products underneath stainless steel sinks, as the fumes released may cause rusting and corrosion.

CHAIRS AND TABLES

To clean tabletops, simply follow the relevant instructions for each worktop material; for veneered or wooden tops, please refer to the paragraph relating to wood.

Finally, from time to time, make sure the tapping screws fixing the legs in place are tightened properly. As for the wooden or lacquered chairs, follow the instructions provided in previous paragraphs; chairs with a metal frame can normally be cleaned using a soft cloth slightly dampened with water or alcohol; natural or synthetic wicker seats do not require any special care, but should be protected with a cushion to guarantee durability. Finally, bear in mind that the chairs are not suitable for outdoor use, and that all four legs should always be in contact with the floor.

VARIOUS COMPONENTS

Hinges: to ensure the hinges last longer, never force the door opening angle, and do not lean on them when they are open; do not leave opened packets or bottles of detergent or other chemical products near them as they may cause rusting.

Edging: edging may break due to the heat emitted by the oven or the steam released by the dishwasher; to glue its edging materials, **Lube Industries** uses thermosetting polyurethane adhesives which are highly resistant to heat and moisture. Nevertheless, we suggest the dishwasher is only opened once it has cooled completely, and that any droplets are dried thoroughly.

Brackets and frames: refer to the instructions provided in previous paragraphs, relating to laminate worktops and wood.

Aluminium frames and skirting: clean using a soft cloth and liquid detergent, rinse and dry thoroughly; never use abrasive products.

Knobs and handles: these are coated with a special stain- and mark-resistant film; abrasive products and solvents (acetone, triline or ammonia) should therefore be avoided as they may damage it. Use a damp cloth instead and dry thoroughly.

Domestic Appliances

GENERAL ADVICE

Domestic appliances should be positioned logically in order to achieve optimal operating and handling conditions. Check the condition of the electricity mains regularly, in particular the efficiency of the earthing system. Do not service the appliance before unplugging it or switching it off at the wall. Do not start or touch domestic appliances when barefoot or when the floor is wet. We advise against the use of adaptors and multiple sockets; the appliance plug should be the only one connected to the power point in order to avoid overheating and short circuits. Furthermore, the electricity supply in the kitchen must include a main differential switch that, in turn, controls an individual safety switch for each appliance.

CAUTION

Always adhere strictly to the Manufacturer's instructions (provided in the manuals supplied with each appliance) and, if requesting assistance, contact the service centres authorised by the Manufacturer directly (you will find this information in the manuals and warranty certificates).

Glossary

STAINLESS STEEL

A steel that is resistant to corrosion and certain chemical agents. To be defined as such it must contain at least 12% of chromium. Stainless steel 18/10 means that it is 18% chromium and 10% nickel. Thanks to its hygiene it is often used in the food industry (pots, sinks, worktops).

ACRYLIC

Acrylic is a thermoplastic material similar in appearance to glossy lacquered finish. It is also non-toxic, remains unchanged over time, retaining all its original characteristics of brilliance, and the colour does not yellow with age. It is resistant to ultraviolet rays and moisture. It is not resistant to the following products: acetone, ink and ethyl-butyl acetate.

ALKORCELL

It consists of a polypropylene-based (PP) decorative sheeting for indoor use free of halogen, plasticiser and formaldehyde. It is suitable for covering surfaces of wood-based materials and is used in the production of furniture components. A thermosetting paint gives the sheeting the properties necessary for these applications. For processes with different gluing systems, the sheeting is reinforced on the back with a primer and the gluing is done with dispersion or hot melt or solvent glues.

ALUMINIUM

Silvery white metal – malleable and very light – mainly used in aeronautics. Used both die-cast and drawn, it is then painted or protected by anodic oxidation processes, which makes the surface layers resistant to scratches and corrosion.

ABS

Acronym that stands for Acrylonitrile butadiene styrene, a polymer based on high-strength synthetic resins used in the construction of packaging, television sets, toys, etc.

CENTRAL PANEL

The central panel of a door is generally made of veneered or covered chipboard.

MELAMINE PAPER

Paper impregnated with melamine resins. It can be of various colours or imitate the grain of wood. It is used for the covering of chipboard panels, which after this treatment are called melamine-faced panels.

POLYURETHANE GLUES

PUR or polyurethane glues are widely used in the carpentry sector and form strong bonds that are resistant to crosswise stresses. It is therefore difficult to remove two elements glued with PUR without damaging them. Another important property of PUR adhesives is that they harden easily.

HOT-MELT GLUES

Adhesives that, when applied in the melted state, create a bond thanks to their cooling and the pressure exerted between the two elements to be glued. They are reversible in that, if brought back to temperatures ranging from about 60°C to 100°C, they soften and temporarily lose their adhesive power.

THERMOSETTING GLUES

Resins that exert their bonding power thanks to chemical reactions that are partly activated by heat. The most important ones in the furniture industry are obtained by combining formaldehyde and other base resins. Having undergone a chemical reaction, they are irreversible adhesives and therefore resist even high temperatures. The polyurethane adhesives used by Lube to glue the edges of the drawers are of this type.

FORMALDEHYDE

Formaldehyde is a substance used for the production of many adhesives and resins, which in turn are also used in the processing of wood panels. Panels produced in this way can release gaseous formaldehyde molecules into the environment. This emission, considered harmful to people's health, is regulated in many countries of the world by specific rules and laws.

The main ones are as follows:

- **European legislation (E1)**

In Europe (for Italy Ministerial Decree 10/10/2008) the current limit is set at 0.1 ppm corresponding to formaldehyde class E1, obtained with testing methods EN 717-1:2004 or EN ISO 12460-3:2015.

- **US legislation (CARB ATCM Phase 2/EPA TSCA Title VI)**

In California, which has always been the US state most attentive to issues of ecology and health, the law currently sets emission limits for all wood-based products. In particular, the ATCM CARB 2 Regulation requires limits to be within 0.09 ppm, according to the American standard ASTM E 1333-69 (2002) (large chamber method), so the California regulations are among the most stringent on the planet. Unfortunately, there is currently no official correlation between the values obtained with the ASTM method and the corresponding method used in Europe (EN 717-1 or EN 717-2). The products concerned must have third-party certifications issued by bodies authorised and recognised by the California Air Resource Board (CARB Phase 2 certification, also called CARB 2). Since 1 June 2018, the CARB limits for California have been extended by the United States Environmental Protection Agency (EPA) to all other federal states, so wood-based materials sold in the US must comply with CARB ATCM Phase 2 and EPA TSCA Title VI.

GLOSS LEVEL

The level of gloss of the painted surface, using a special instrument called a glossmeter:

- Matt: up to 10 gloss units - Semi-matt: from 11 to 35 gloss units - Semi-glossy: 36 to 60 gloss units - Glossy: from 61 to 80 gloss units - Highly glossy: over 80 gloss units

GRANITE

It is one of the most abundant rocks on the earth's surface. It is an intrusive igneous rock (it originates when magma remains trapped in the earth's crust, solidifying at depth). Its name comes from the Latin granum (grains), with clear reference to its holocrystalline structure (granular), so from an aesthetic point of view the granite presents itself in grains. It is mainly composed of quartz (between 20 and 60%) and therefore contains hard materials.

GLAKS

Organic glass with the same aesthetic characteristics as glass, but with a number of important advantages: it is unbreakable, resistant to scratches, chemicals and impacts. It can be worked with standard woodworking tools and machines and is available in custom sizes.

WATER REPELLENT

In the furniture sector, "raw" chipboard, MDF or plywood panels are considered water repellent if they resist the swelling caused by water in the wood fibres for a certain period of time, as established by regulations. This resistance is not absolute and there is a scale of values. Maximum resistance corresponds to the definition of a water-repellent panel. Of course other factors like the type of veneer and gluing/sealing of the edges also contribute to the panels' water resistance.

LACQUERING

Lacquering is a type of varnishing that uses lacquer, i.e. a coloured polyester and/or polyurethane covering that hides the veins of the wood, unless it is open-pore varnishing, i.e. a varnishing that colours and allows the veins of the wood underneath to be seen.

UV LACQUERING

A type of coating (lacquering) where the products applied are hardened thanks to irradiation carried out by special lamps that emit high-energy ultraviolet light. These systems allow for a very quick and effective hardening of the resins, which normally produce very hard and resistant films.

LAMINATE

Also known by the trade name "formica", it is made of phenolic resins (support) and melamine resins (decorative paper) glued together in such a way as to form sheeting of about 0.6 mm.

It is used to cover wooden panels (laminated panels). Laminates where the thickness of the support resins is greater than 1 mm are defined as layered

laminates which, thanks to their mechanical characteristics, can be used as self-supporting panels without being applied to wood panels.

POSTFORMING LAMINATE

Application of a laminated surface on a substrate of irregular shape (usually curved or otherwise shaped), as with the machine edging of a panel.

HPL LAMINATE

HPL stands for High Pressure Laminates. Laminates of this type are composed of layers impregnated with phenolic resin and a decorative covering impregnated with melamine resin, agglomerated under the combined effect of heat and high pressure, thus giving life to a product with exceptional qualities of hardness and resistance to scratches, wear, impacts, chemicals and fire. They are mainly used for worktops.

WOOD

Wood is taken from tree trunks. It is, therefore, a natural material with all the characteristics this implies. Differences in grain or shade between the different parts cannot therefore be considered as a cause for complaint. Cucine LUBE has nonetheless included strict controls on wood finishes and combinations in its Quality System, in order to reduce any problems to a minimum. Exposure of wood to direct sunlight may cause entirely normal changes in colour, linked to the natural change in the material. The wood matures over time and may turn a slightly different shade, which should not be considered as a defect. It should be remembered that, even after processing, it behaves like a living product, changing in volume as the humidity in the surrounding environment changes.

MARBLE

Marble is a metamorphic rock composed mainly of calcium carbonate (CaCO_3), therefore it contains semi-hard materials. Marble is formed through a metamorphic process from sedimentary rocks, like limestone or dolomite, which causes a complete recrystallisation of its primary component, calcium carbonate.

From an aesthetic point of view, marble looks like a homogeneous paste.

MDF PANEL

MDF stands for medium density fibreboard and is made of branches and woodworking scrap. These panels are ecologically interesting because their production does not involve the systematic felling of trees. They are made up of wood fibres obtained by steam and special machines and then bound together with thermosetting adhesives. Once pressed, these fibres (very similar to cotton wool) give the panel good mechanical characteristics, excellent dimensional stability and compactness along the edges, making it indispensable for the production of lacquered panels, veneered with PVC, and in cases where large surfaces are needed, where the wood could present problems of flatness. However, they have a high weight and generally low resistance to moisture.

CHIPBOARD PANEL

Defined as a wood particle board, it mainly consists in wood processing scrap and residual tree branches. This makes it an ecological product as it does not require the felling of trees. It is made of wood chips and particles pressed and glued together with thermosetting adhesives. It is commonly used after veneering, finishing with melamine paper or covering with PVC or laminate, materials that give the panel the desired aesthetic qualities.

From a mechanical point of view, a chipboard panel has an excellent dimensional stability that makes it essential for use on large surfaces where solid wood would have enormous problems remaining flat. It is also much lighter than MDF, but also has very little resistance to moisture, especially in its raw state. However, the materials normally used to cover it guarantee a good resistance to water, especially depending on the type and method of the covering.

MELAMINE-FACED PANEL

Chipboard panel whose surfaces have been covered with sheets of paper impregnated with melamine resins.

PLYWOOD PANEL

Panel made when five or more layers of wood are combined with perpendicular grains and bonded with water- and moisture-resistant adhesives.

PET

PET is the abbreviation of polyethylene terephthalate, a synthetic thermoplastic material that is part of the polyester family. It is a thermoplastic resin that is suitable for contact with food but it is also used in other areas, including the medical and cosmetic industries and more recently in the furniture sector. A product originally produced from petroleum or methane gas which can be recovered and endlessly transformed without losing its properties and resistance. Although its characteristics are similar to PVC, it has the great eco-friendly benefit, unlike polyvinyl chloride, of not producing any toxic substances during combustion. PET is thus a valued material that respects the environment and can easily be recycled and used to make excellent products. Doors covered in this material are made with MDF panels on which PET sheets are applied with a thickness varying between 0.3 mm and 0.4 mm, according to the type of finish.

VENEER

A thin sheet of wood (about 0.6 mm) cut from tree trunks. It is used to cover wood panels (MDF, chipboard, solid wood, etc.), which are then referred to as veneered.

PLATING

Operation of covering a raw panel with various materials like laminate, PVC, veneer, etc.

POLYPROPYLENE

Polypropylene (PP) is an environmentally friendly thermoplastic polymer with high quality production technology. It is also a product resistant to acids, solvents, light and moisture, characteristics that make it particularly suitable as an alternative to the more popular PVC and ABS.

PVC

Polyvinyl chloride is one of the most widely used plastic materials in the furniture industry. It is used to cover both structural elements and doors. It is regarded as non-ecological, but in reality the possible risk factors relate solely to the phases of production and destruction of the material (unless burnt in special incinerators, it can produce harmful emissions). It can be coloured and can imitate wood grains. Being a thermoplastic material, it is not very resistant to heat and tends to change form at temperatures between 75 and 95°C.

SCREEN PRINTING

A special printing method where ink is passed through the mesh of a silk fabric (screen) except where the mesh has been blocked by an impermeable masking. When used on glass, the screen printing can be tempered at high temperatures so that it becomes indelible on the glass.

PAINT THICKNESS

The thickness of the dry film of paint on a component is identified by measuring the thickness of the quality of paint applied:

- Open pore: up to 5 microns thick - Semi-open pore: 6 to 20 microns thick - Semi-closed pore: 21 to 60 microns thick - Closed pore: over 60 microns thick

FRAME

Full load-bearing structure, usually rectangular, made by joining four or more strips. If the frame is rectangular, the vertical elements are called uprights and the horizontal ones cross members.

ACRYLIC PAINT

Paint with very high resistance to light that performs better with respect to yellowing. It is often used with light woods where any yellowing of the paint would cause a very unpleasant colour change. It gives the wood a very natural appearance as it can be applied with a minimum of thickness without creating the effect of covering the wood panel with a transparent film.

POLYURETHANE PAINT

The most used in the wood sector because it is economical and easy to apply.

As it has little resistance to light, it tends to turn yellow and is therefore not suitable for painting light-coloured wood.

POLYESTER PAINT

Normally used where thick paints with excellent mechanical resistance (lacquered panels) are required. As it is harder than acrylic or polyurethane paints, it is normally also used on table tops and other elements subject to wear. It can be polished (glossy lacquer) with systems that use increasingly fine grits until a mirror surface is achieved.

Polyester paints also have low resistance to light and therefore are not suitable for producing very light-coloured coatings that yellow easily.

WATER-BASED PAINT

Used for new ecological painting systems where the solvent used is water.

This solves significant environmental problems (just think that in some cases during drying as much as 70% of the product applied evaporates in the form of polluting solvents). Water-based paints are still in the experimental phase.

TEMPERED GLASS

Glass with special hardness and impact resistance obtained through tempering.

This process consists in heating the glass to high temperatures (650°C) and then cooling it rapidly by blasting it with jets of air.

ZAMAK

Alloy made of pure zinc, aluminium and magnesium, which in addition to being significantly inert from a chemical point of view, lends itself very well to the processes of die-casting.

In the furniture sector it is used mainly for the production of knobs and handles.

Use and Maintenance



TALL REFRIGERATOR UNIT

For the refrigerator to operate correctly, the tall unit must offer constant ventilation; this is provided by a special plastic pre-drilled plastic base which allows air to enter from under the unit door and to flow out at the top. Therefore, nothing should be placed on top of or underneath the tall units. We also advise against placing the refrigerator near sources of heat, such as an oven, hob or radiator. Make sure that all tall units are secured using a suitable wall fixing plate to prevent them from tipping over.

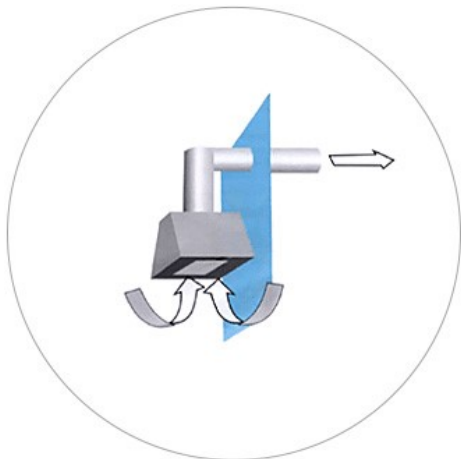

EXTRACTOR HOOD

It is important to use the extractor hood because it captures fumes and releases them outside; it must, however, be connected to a special flue with a suitable pipe. Do not connect the extractor hood to a flue already used for other waste gases (produced by boilers or chimneys, for example).

The disposable synthetic fibre grease filter should be replaced every 2 months. The metal grease filter should be cleaned in the dishwasher every 2 months.

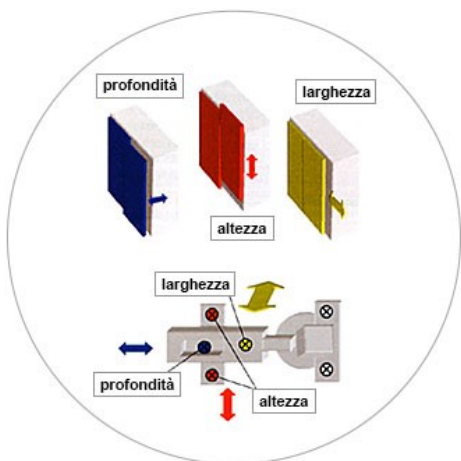

HINGES

Over time, the door hinges may become misaligned. They can, however, be readjusted: the three arrows in the figure illustrate how to adjust the height, width and depth of each door. The depth adjustment hinge can also be used to remove the door from the unit completely.

WALL UNIT - SHELF SUPPORT HOOK

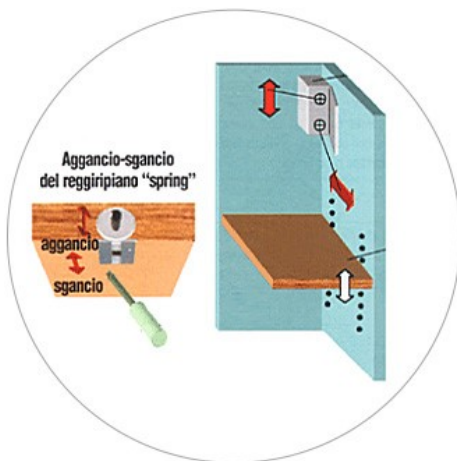

The wall unit is fastened to the wall unit support bar with hooks which can be used to adjust the height and depth measurements of the unit by means of special screws located underneath a plastic flap, as illustrated in the figure.

The shelf support devices allow secure installation inside the unit and prevent the shelves from tipping up. Simply use a screwdriver (as illustrated in the figure) to fit or remove a shelf. A series of holes has been drilled in the side of the unit so that the shelf can be positioned at the desired height.

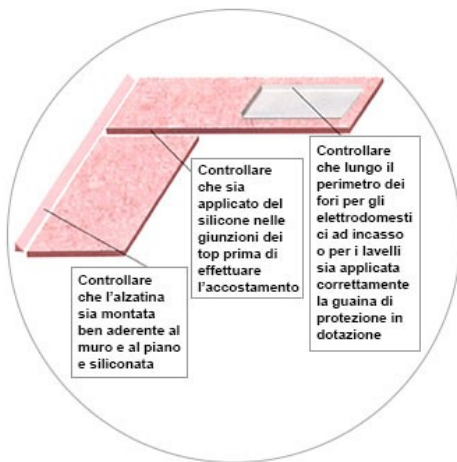

WORKTOP

1. Make sure that the protective sheath provided has been applied correctly around the openings for fitted domestic appliances or sinks.
2. Make sure silicone is applied to the joins in the top before bringing the pieces together.
3. Make sure the backsplash has been secured to the wall and worktop, then sealed with silicone if necessary.



FEET AND SKIRTING

To facilitate work underneath the units, the kitchen skirting is fastened to the feet using snap-on plastic hooks; simply push or pull the skirting as required. These hooks may be aligned with the feet thanks to a special runner on the skirting itself.

The height of tall and base unit feet can be adjusted if the floor is not perfectly even, so that the kitchen is level; simply turn the threaded base of each foot as illustrated in the figure.

TOTAL EXTRACTION DRAWERS

To **attach** the drawer front, simply fit the special expansion insert to the front panel and fix it in place as illustrated in the figure; then simply bring the front panel with the secured inserts closer to the side panels until the springs slot into the grooves.

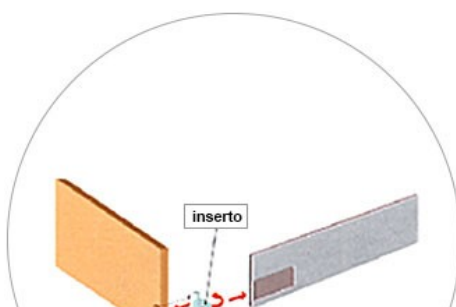



To **detach** the drawer front panel, simply insert a crosshead screwdriver into the relevant slot after removing the protective plastic; next, turn it in a clockwise direction until the panel comes loose.

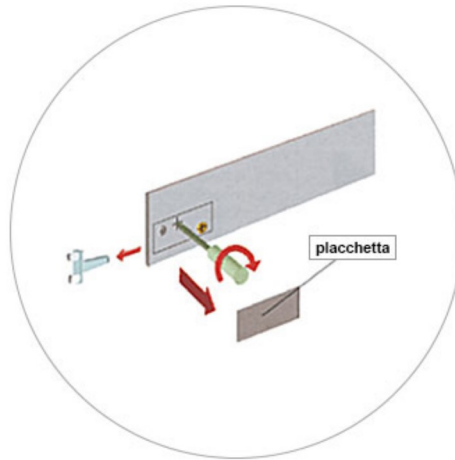

To **adjust the height** of the front panel, use the gold-coloured screw as illustrated in the figure.

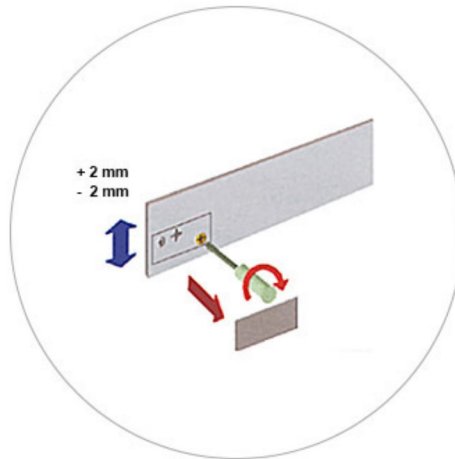

To **adjust the drawer side panels**, use the grey plastic bushing as illustrated in the figure.

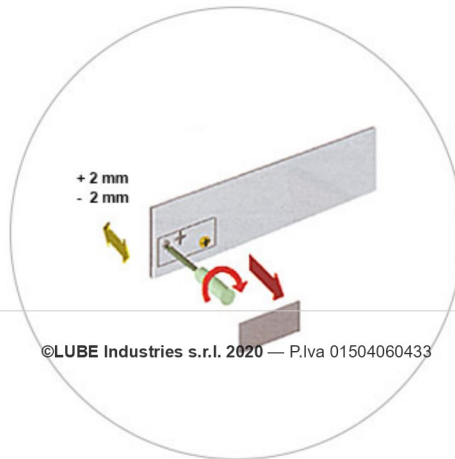

©LUBE Industries s.r.l. 2020 — P.Iva 01504060433

To **adjust the angle of the front panel**, proceed as illustrated in the figure and turn the rail.

To install the rails:

1) insert the rail 2) lift the back of the rail 3) slot the rail into the back panel.



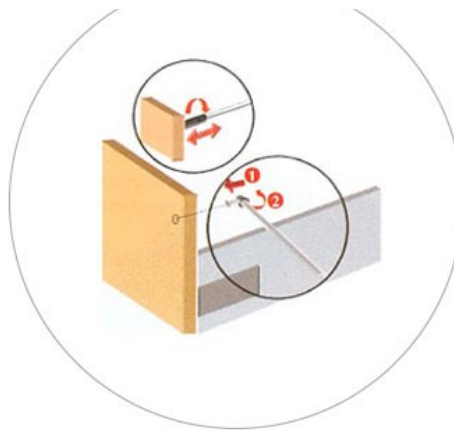

Wall unit support bar installation dimensions in accordance with the height of the wall units and the feet h=15 cm

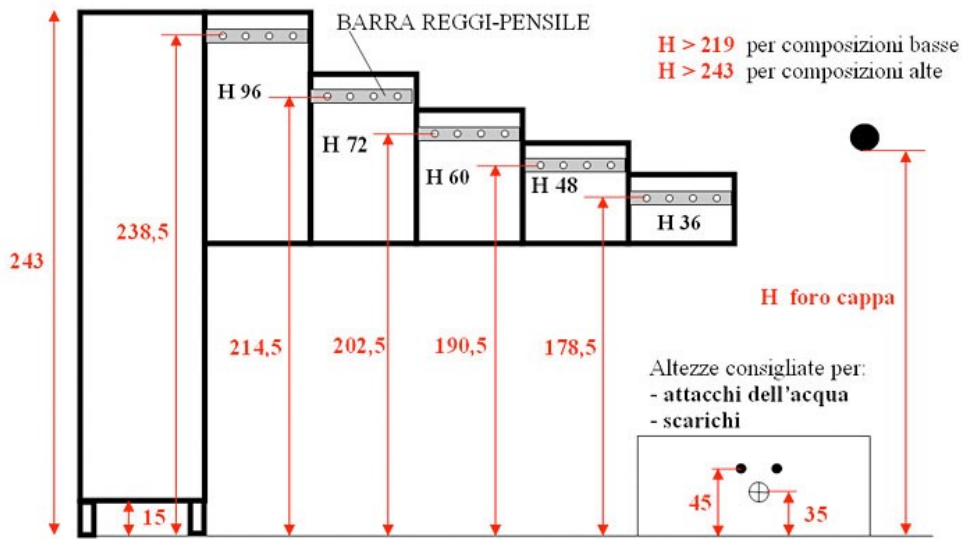
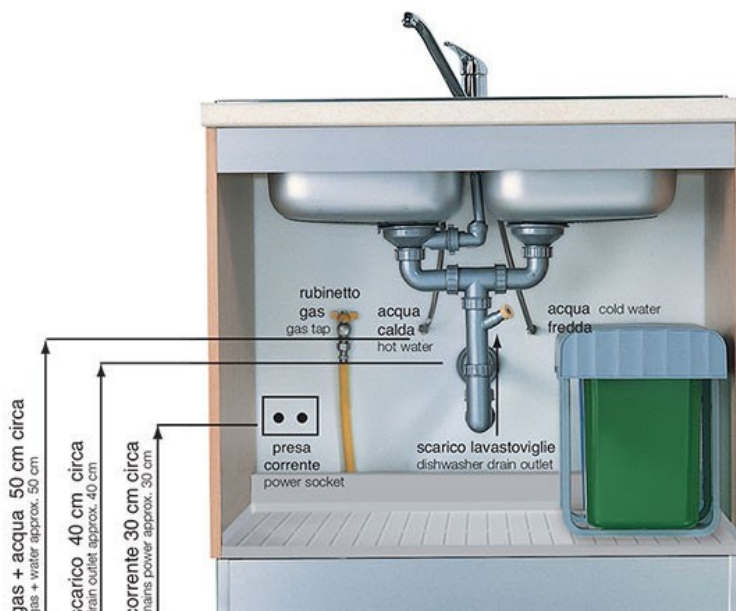

Diagram of electrical, water and gas connections

UNDER-SINK UNIT WITH DOORS





UNDER-SINK UNIT WITH TWO DEEP DRAWERS AND SPACE-SAVING DRAIN PIPE

